

# An efficient modeling technique for floor vibration in multi-story buildings

Dong-Guen Lee<sup>\*</sup>, Sang-Kyoung Ahn<sup>†</sup> and Jinkoo Kim<sup>‡</sup>

*Dept. of Architecture, Sungkyunkwan University, Suwon, 440-746. Korea*

**Abstract.** The analysis of a framed structure for vertical vibrations requires a lot of computational efforts because large number of degrees of freedom are involved in the dynamic responses. This paper presents an efficient modeling technique for vertical vibration utilizing substructuring technique and super elements. To simplify the modeling procedure each floor in a structure is modeled as a substructure. Only the vertical translational degrees of freedom are selected as master degrees of freedom in the inside of each substructure. At the substructure-column interface, horizontal and rotational degrees of freedom are also included considering the compatibility condition of slabs and columns. Finally, the Guyan reduction technique is applied to enhance the efficiency of dynamic analysis. For further simplification, the repeated parts in a substructure are modeled as super elements, which reduces computation time required for the construction of system matrices in a substructure. In numerical examples, the efficiency and accuracy of the proposed method are demonstrated by comparing the response time histories and the analysis time.

**Key words:** vertical vibration, Guyan reduction, master DOF, substructuring technique, super elements

---

## 1. Introduction

Framed structures such as buildings or plants are vulnerable to floor vibrations excited by various mechanical equipments. Those equipments are usually placed on beams or slabs, and the vibration pattern depends largely on the location of the equipments and the dynamic characteristics of the load and the structure. In a dynamic problem caused by a vibration source located on a floor, the vertical component of response is generally predominant mainly because of the smaller out of plane stiffness of the floor. Unlike the dynamic problems caused by lateral loads, such as earthquake or wind load, the vibration

---

\* Professor

† Graduate Student

‡ Assistant Professor

characteristics associated with the floor vibration have diverse aspects. When the source is located inside of the structure, the vibration is generally localized to the surrounding areas of the source. Sometimes, however, the vibration spreads to the whole structure when the dynamic effect of the load coincides with the global vibration characteristics of the structure. In either case, the number of vibration mode involved is much larger than that of horizontal vibration problems, because each of the structural members participates in the dynamic responses.

In dynamic responses of a framed structure excited by a source located on a floor, the contribution from the bending stiffness of beams and slabs is quite substantial. Therefore they need to be meshed into as many finite elements as necessary to describe the dynamic characteristics accurately. However, as the degrees of freedom increase, the computation time increases more rapidly, sometimes up to the point that the analysis becomes practically infeasible. Accordingly in engineering practice, a special technique should be introduced to secure reasonable computation time and cost. In this case the Guyan reduction technique (Guyan, 1965) is generally applied to reduce the size of the eigenvalue problem. However, as the technique requires *a priori* knowledge of the master degrees of freedom to be retained in the analysis procedure, an appropriate criterion to select the master degrees of freedom is essential.

There are qualitative guidelines available to decide how many and which degrees of freedom to select as master degree of freedom. Levy (1971) proposed to select the degrees of freedom having large displacements or those having large mass components. Ramsden and Stoker (1969) selected the master degrees of freedom associated with large mass concentrations. These criteria are considered to be inadequate since they require the *a priori* knowledge of the selection. Downs (1980) proposed that the chosen degrees of freedom must always be translations as opposed to rotations. Shah and Raymund (1982) proposed an algorithm that the ratio of the diagonal terms of stiffness matrix  $K$  and mass matrix  $M$  corresponding to the eliminated degrees of freedom is a maximum. This algorithm is said to be well adapted to structures whose geometry and mechanical characteristics are relatively uniform. However, in their approach, the determination of the cut off frequency is left to the expertise and judgement of the engineer. Even for the same structure, the cut off frequency should be varied according to the location and the frequency content of the load.

In this study an efficient modeling technique for vertical vibration of a framed structure is proposed utilizing the substructuring technique and the super element. The vertical translational degrees of freedom are selected as master degrees of freedom in the inside of each substructure, and at the substructure-column interface, horizontal and rotational degrees of freedom are included to meet the compatibility condition of different substructures. For further simplification of the modeling procedure, the repeated parts in a substructure are taken as a superstructure. In this way the time for constructing and condensing the stiffness and mass matrices in a substructure can be greatly reduced. In numerical examples, the maximum responses and the analysis time obtained following the proposed procedure are compared with the results obtained from the procedure proposed by Shah and Raymund (1982).

## 2. Development of efficient modeling technique

### 2.1 Analytical model of a building structure for floor vibration

For a seismic analysis of a building structure, in which the horizontal component of vibration is the primary concern, the floors are generally considered as a rigid mass with no vertical degree of freedom (Fig. 1(b)). On the other hand, the dynamic characteristics of floors are most important in the case of local vibration of a floor excited vertically by a mechanical equipment or other vibration sources located on or near the floor (Fig. 1(c)). In this case the precise representation of the dynamic characteristics of a floor depends greatly on the number of finite elements that the floor is divided into.

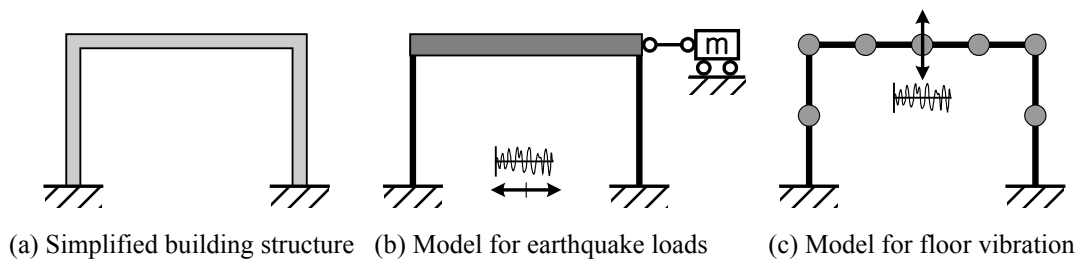

Fig. 1 Analytical modeling of a building structure

### 2.2 Effect of mesh division

The accuracy of finite element analysis, of course, increases with the number of the finite elements. However the floor cannot be divided indefinitely if the cost and computational efficiency are taken into account, and there should be an appropriate compromise between accuracy and efficiency. To investigate the effect of mesh division on the computation of the dynamic characteristics, a simple single-story reinforced concrete framed structure shown in Fig. 2 is analyzed. The slab is supported by beams and columns along the boundaries. The size of the beams and columns are 45 cm  $\times$  60 cm and 45 cm  $\times$  45 cm, respectively, and the thickness of the slab is 20 cm. The slab is divided into 2 $\times$ 2, 4 $\times$ 4, 8 $\times$ 8, and 16 $\times$ 16 identical finite elements as described in Fig. 2., and the eigenvalue analysis was carried out for each case. Fig. 3 shows the natural frequencies of the model structure with each slab mesh division. It can be seen that for the given structure that the division into 16 finite elements (4 $\times$ 4) turns out to be quite satisfactory, whereas the natural frequencies obtained from the structure with 2 $\times$ 2 mesh division deviate from the other cases.

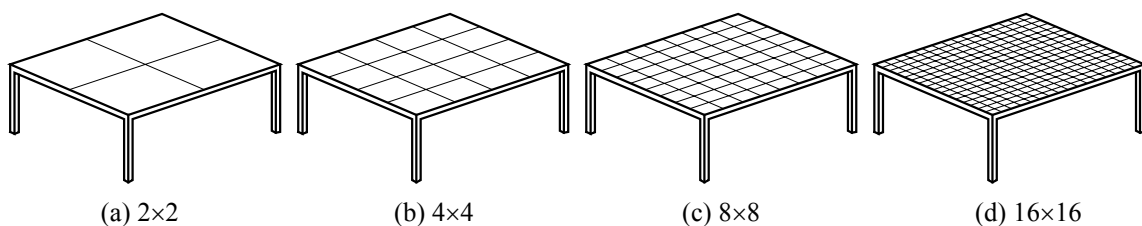

Fig. 2 Mesh division of a slab for floor vibration analysis

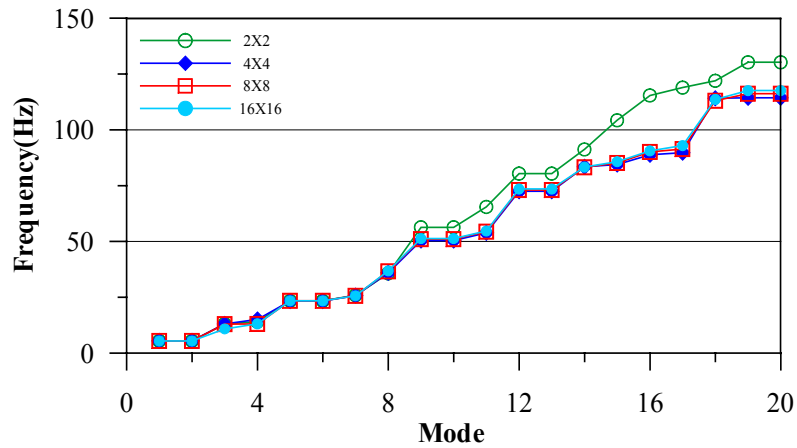

Fig. 3 Comparison of natural frequencies of a floor with different mesh division

The same conclusion could be drawn for the two story, 2x3 bay framed structure described in Fig. 4. The section properties are the same with the previous model. Parts of the natural frequencies for each mesh division case are presented in Table 1. In the 1st to 10th modes the four cases show similar results. However in the 70th to 80th modes the natural frequencies for the case with 2x2 mesh division deviate from those for the other cases. It also can be noticed that the results for 4x4 mesh division are quite close to those for more refined mesh division cases. The comparison of the computation time shown in Table 2 demonstrates the efficiency of the 4x4 mesh division more clearly.

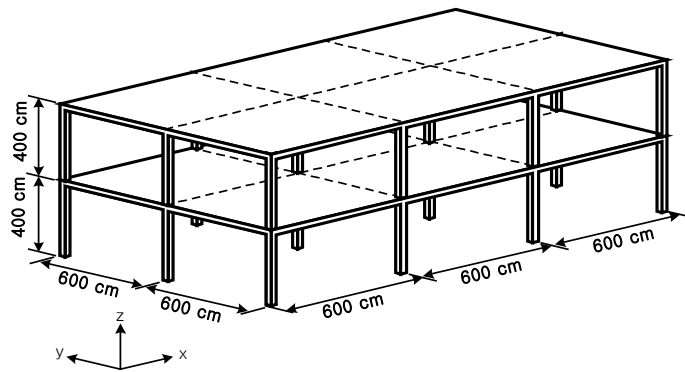

Fig. 4 Example structure with many slabs

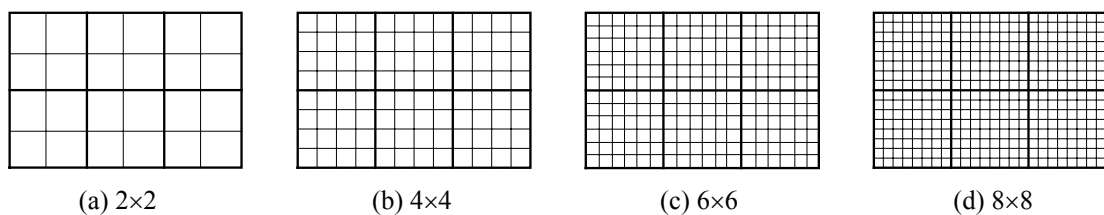

Fig. 5 Mesh division for floor vibration analysis

Table 1 Comparison of the natural frequencies for the example structure (Hz)

Model \ DOF	2x2	4x4	6x6	8x8
Mode	420	1404	2964	5100
1	3.411	3.401	3.400	3.400
2	3.486	3.477	3.476	3.476
3	4.177	4.166	4.164	4.164
4	11.329	11.308	11.305	11.304
5	11.469	11.449	11.446	11.445
6	13.784	13.756	13.752	13.751
7	14.471	14.483	14.522	14.539
8	14.474	14.514	14.564	14.585
9	15.007	15.103	15.172	15.201
10	15.269	15.255	15.297	15.315
:	:	:	:	:
70	60.016	53.794	54.249	54.550
71	60.630	54.012	54.583	54.935
72	60.638	54.477	54.769	54.993
73	61.310	55.383	55.739	56.005
74	63.161	56.715	57.016	57.262
75	63.290	56.779	57.068	57.301
76	63.896	56.965	57.381	57.696
77	64.479	57.487	57.948	58.284
78	65.134	58.423	58.878	59.135
79	65.634	58.446	59.026	59.387
80	66.647	59.080	59.689	60.075

Table 2 Computation time in each analytical step for the example structure (sec)

Model \ Procedure	Assembly of M & K	Eigenvalue analysis	Total
2x2	1.03	19.83	36.48
4x4	8.44	811.06	986.85
6x6	25.17	8563.84	9352.02
8x8	64.77	165213.80	174442.91

### 2.3 Selection of master degrees of freedom

To apply the Guyan reduction technique to a dynamic problem, it is required to select some degrees of freedom as the masters to be retained, and the remaining ones are classified as slaves to be condensed out in the reduction process. The static relationship between masters and slaves is employed to reduce the size of the eigenvalue problem, while preserving the total kinetic energy and strain energy in the structure. The successful application of the reduction process, however, depends greatly on the selection of appropriate master degrees of freedom; an improper selection may result in missing some of the important frequencies in the reduced dynamic problem.

In this study a more efficient and straightforward procedure for selection of master degrees of freedom is used, which can be stated as follows: (1) In a floor only the vertical component is retained among the six degrees of freedom in a nodal point; (2) At the column-floor interface, all of the six degrees of freedom are included in the master degrees of freedom for satisfying the compatibility condition.

To validate the adequacy and effectiveness of the proposed process, the dynamic characteristics of a simple reinforced concrete structure described in Fig. 2 is investigated again. The dotted lines in Fig. 6 denote the division into finite elements. In Fig. 7, the values  $\omega_c \left( = \sqrt{k_{ii}/m_{ii}} / 2\pi \right)$  corresponding to the degrees of freedom located along the lines a-a' and b-b' marked in Fig. 6 are plotted. The line a-a' passes along the edge of the slab, where the beam is located, and the line b-b' passes in the middle of the slab. As six degrees of freedom, i.e. three translations and three rotations, are considered in each node, the vertical grid lines in Fig. 7 are drawn in the interval of 6 degrees of freedom. It can be seen in the figures that the values corresponding to the translational components (the first three DOF between vertical grid lines) generally have lower values than those associated with the rotational degrees of freedom; and among the three translational degrees of freedom, the vertical component (third DOF) has the lowest value. Therefore it can be concluded that the vertical degrees of freedom should be retained as the master degrees of freedom. However, as can be seen in Fig. 7 corresponding to line a-a', there are cases that the horizontal and the rotational components as well as the vertical component also retain lower frequency values. Therefore the vertical components needs to be retained at boundaries

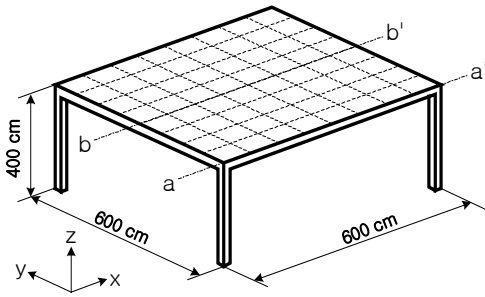

Fig. 6 8x8 finite element division of slab

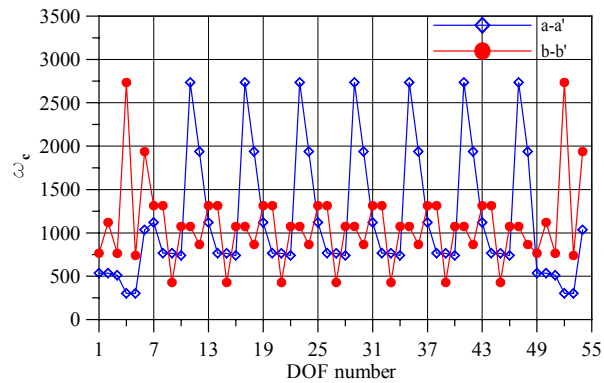

Fig. 7 Variation of the ratio  $\omega_c$

To investigate the accuracy of the proposed selection criterion of master degrees of freedom, the six different cases of selection criteria described in Fig. 8 are compared; Model-A: all DOF's, Model-B: three translational DOF's per node as masters, Model-C: only vertical DOF's as masters, Model-D: vertical DOF's and all six DOF's at the interface (proposed criterion), Model-E: similar to Model-D but with no DOF's at the boundary, and finally Model-F: similar to Model-D except that the vertical DOF's at the boundary are replaced by rotational DOF's.

The natural frequencies obtained from the eigenvalue analysis of the six cases of the selection criteria for master degrees of freedom are compared in Table 3. The natural frequencies obtained using all DOF (Model-A) are free from the approximation of the Guyan reduction process, and are used to evaluate the accuracy of the other methods. It turns out that the largest error occurs when only vertical degrees of freedom at all nodal points are selected (Model-C); this selection criterion is inappropriate since the

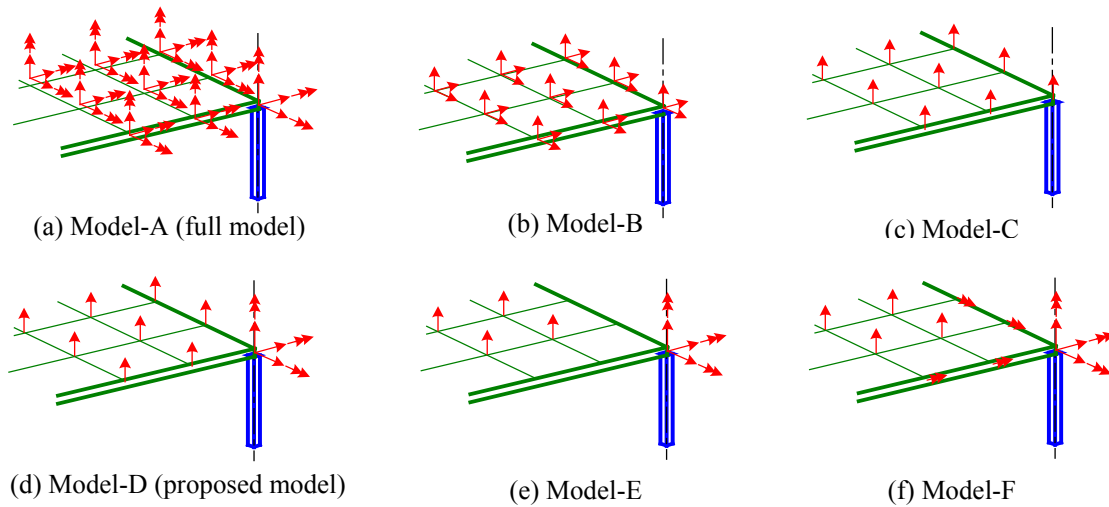

Fig. 8 Selected master DOF's for various selection criteria

important horizontal components in low frequency range are ignored. The proposed method (Model-D) which satisfies the compatibility condition between the slab and the columns provides reasonably accurate results using only a fourth of the full degrees of freedom. In contrast, the models that the vertical DOF's at the boundary are omitted (Model-E) or replaced by the rotational DOF's (Model-F) produce less accurate results even with the same number of degrees of freedom with the proposed model. This coincides with the findings of Downs (1980) that the effect of the rotational degrees of freedom is not significant. The proposed method also has the advantage that no expertise is necessary in the selection of the master degrees of freedom, which is favorable for practical application.

Table 3 Comparison of the natural frequencies for example structure (Hz)

Model	A	B	C	D	E	F
DOF	486	243	81	101	73	101
Mode						
1	5.485	5.485	-	5.490	5.490	5.490
2	5.485	5.485	-	5.490	5.490	5.490
3	13.014	13.015	-	13.037	13.037	13.037
4	13.149	13.150	13.150	13.150	13.180	13.170
5	23.446	23.449	14.089	23.447	24.017	23.802
6	23.446	23.449	14.089	23.447	24.017	23.802
7	25.753	25.757	23.509	25.753	27.004	26.471
8	36.653	36.663	23.509	36.657	38.871	38.011
9	51.077	51.123	25.760	51.092	55.414	53.408
10	51.077	51.123	36.664	51.092	55.440	53.408
11	54.444	54.512	52.106	54.462	55.440	55.383
12	73.116	73.329	54.530	73.178	77.057	76.856
13	73.116	73.329	55.824	73.178	77.057	76.856
14	83.285	83.886	55.824	83.388	90.079	87.074
15	85.203	85.708	85.808	85.468	93.369	92.424
16	90.120	90.408	88.938	90.379	96.824	96.515
17	91.450	91.657	88.938	91.534	104.817	97.603
18	113.119	113.378	90.413	113.235	121.608	119.573
19	116.225	118.244	91.690	116.978	121.608	120.914
20	116.225	118.244	113.385	116.978	124.149	120.914

### 3. Dynamic substructuring using super elements

Building structures are typically composed of columns, beams and slabs, and generally the same elements are repeated for two or three consecutive stories for the convenience of construction. Therefore it would be economical to construct the mass and stiffness matrices of a story (or a substructure) and to use them repeatedly for the subsequent stories. Fig. 9 (a) describes the modeling procedure that each floor system of the structure is modeled as a separate substructure. Each substructure is meshed into finite elements, as shown in Fig. 9 (b), and after the master degrees of freedom are selected the matrix condensation technique is applied to each substructure. Fig. 9 (c) shows the master degrees of freedom selected for the part marked as *a* in Fig. 9 (a). Only the vertical degrees of freedom are selected in the slab, but for satisfying compatibility between the substructures and the beams, 6 degrees of freedom are considered in the interface nodes.

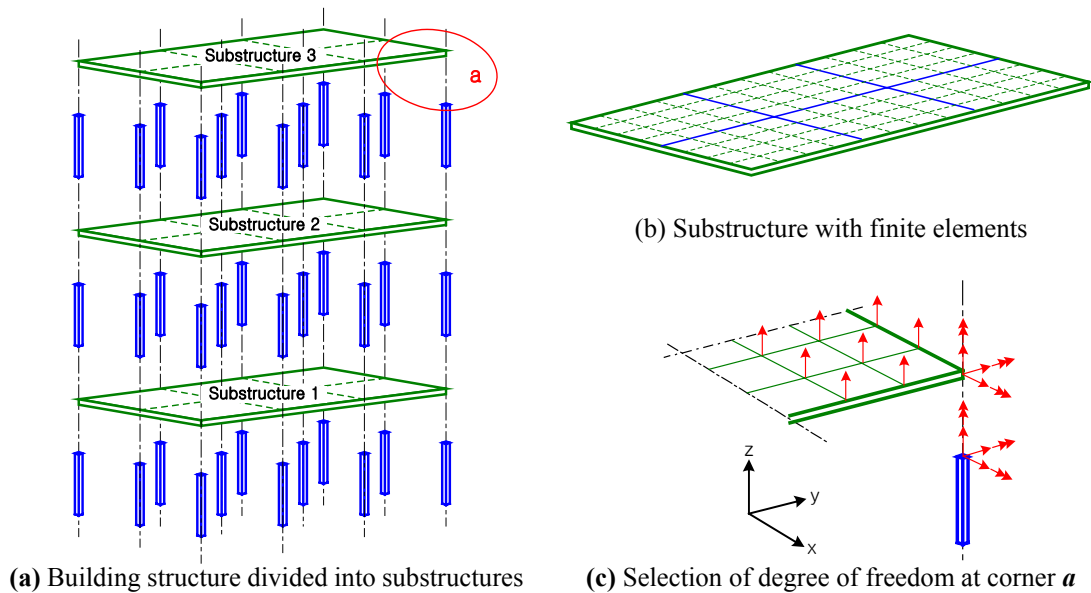

Fig. 9 Selection of substructure and master degrees of freedom

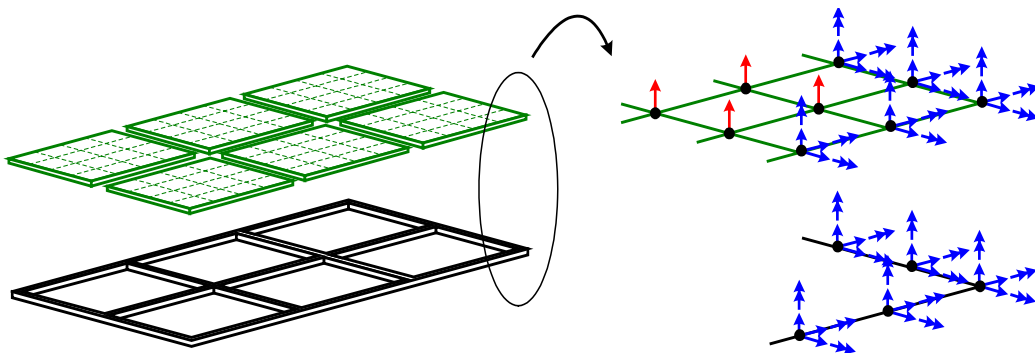

Fig. 10 Substructure modeled as a super element



In case there are many elements and nodes included in a substructure, significant time may be required in the process of assembly and condensation of system matrices. In this case the computation time can be further reduced by taking typical members as super elements and carrying out the process of matrix assembly and condensation in the super element. The results can be reused repeatedly for the other super elements in the substructure. Fig. 10 shows that the slabs enclosed in the floor beams are separated and modeled as super elements. Also shown are the retained degrees of freedom of a super element and the remaining frame elements. The matrix condensation and the selection technique for the master degrees of freedom can be similarly applied to the super element. Following the Guyan reduction process the reduced stiffness and mass matrices of the  $i$ th substructure are expressed as follows

$$\mathbf{K}_i^* = \mathbf{K}_{mmi} - \mathbf{K}_{msi} \mathbf{K}_{msi}^{-1} \mathbf{K}_{smi} \quad (1)$$

$$\mathbf{M}_i^* = \mathbf{M}_{mmi} + \mathbf{T}_{smi}^T \mathbf{M}_{msi} + \mathbf{M}_{smi} \mathbf{T}_{msi} + \mathbf{T}_{msi}^T \mathbf{M}_{mmi} \mathbf{T}_{msi} \quad (2)$$

where  $\mathbf{K}$  and  $\mathbf{M}$  represent the stiffness and mass matrices, respectively, and  $\mathbf{T}_{msi} = -\mathbf{K}_{ssi}^{-1} \mathbf{K}_{msi}$  is the transformation matrix. The subscript  $s$  denotes the matrix that is to be eliminated (slave), and the subscript  $m$  refers to one that will be retained (masters).  $\mathbf{K}_i^*$  and  $\mathbf{M}_i^*$  represent the reduced stiffness and mass matrix, respectively.

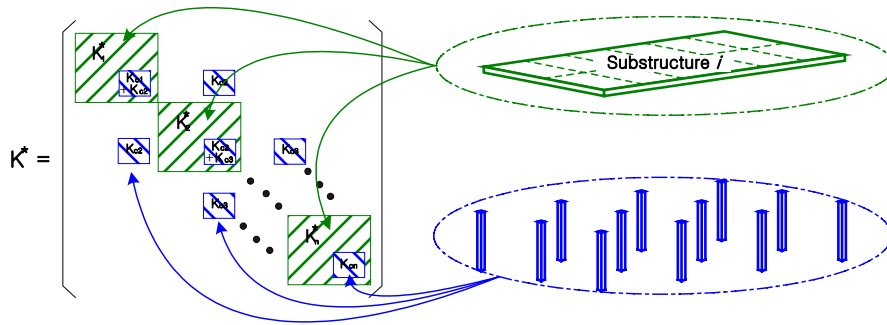

Fig. 11 Construction of stiffness matrix for global system

When the same substructures are repeated in many stories in a structure, the global system matrices can be easily constructed by simply incorporating the matrices contributed from the substructures in the corresponding locations, as described in Fig. 11. Finally the equation of motion expressed in the reduced system matrices can be expressed as follows

$$\mathbf{M}^* \ddot{\mathbf{D}} + \mathbf{K}^* \dot{\mathbf{D}} = \mathbf{A}^* \quad (3)$$

where  $\mathbf{D}$  and  $\mathbf{A}$  are the displacement and load vector, respectively.

#### 4. Application of the proposed method

The validity and efficiency of the proposed selection criterion of master degrees of freedom and the use of super elements are investigated with the reinforced concrete framed structures shown in Fig. 12, Fig. 18, and Fig. 21. The three-story structure shown in Fig. 12 is considered first. The size of the structural members are the same with the previous model (Fig. 4). The slab enclosed by beams is divided into 16 identical finite plate elements with 6 degrees of freedom per node. The total number of degrees of freedom in the structure is 2106. The dynamic load described in Fig. 13 is enforced vertically at the location “A” on the top floor. The frequency contents of the excitation is widely distributed, with a few dominant ones at 15.14 Hz, 30.28 Hz and 45.42 Hz, etc.

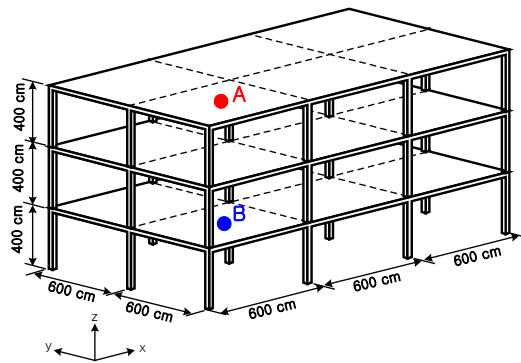

Fig. 12 Example structure with slabs

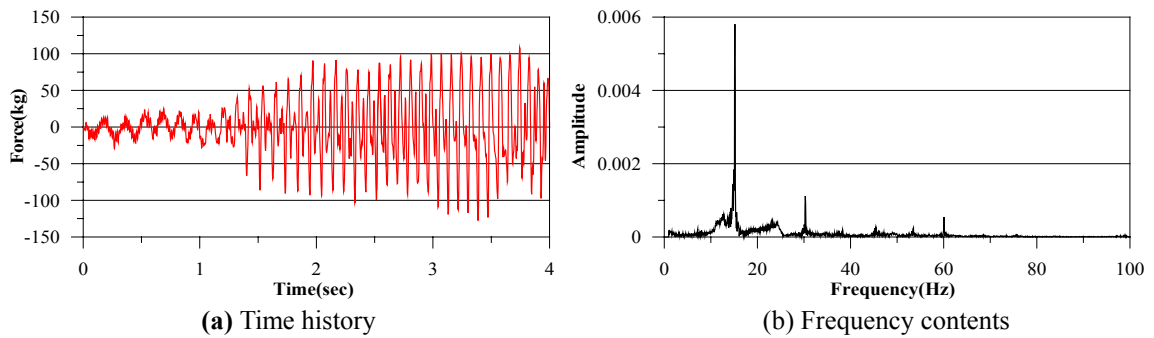

Fig. 13 Dynamic load applied at point A

In the structure, the model with all of 2106 degrees of freedom is designated as Model-1 as shown in Fig. 14 (a). Model-2 corresponds to the proposed method for the selection of master DOF's. In the model-3 and 4 the method of Shah and Raymund (1982) is applied with two different cut-off frequencies;  $\omega_c = 150$  and 200 Hz, which result in the selection of 378 and 531 master degrees of freedom, respectively. For the given structure, the degrees of freedom selected in the proposed modeling technique (the Model-2), turns out to be identical to those of the Model-4 which corresponds to the Shah and Raymund's method with the cut-off frequency  $\omega_c = 200$  Hz. The number of DOF's selected for each model is to listed in Table 4.

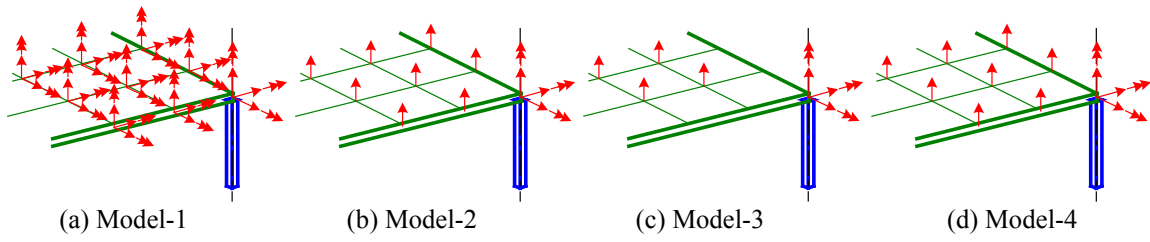

Fig. 14 Selected master DOF's for the example structure

Table 4 Analytical models and the selected number of DOF for the structure with slabs

Model	1	2	3	4
Method	Full model	Proposed method	Shah & Raymund $\omega_c = 150$	Shah & Raymund $\omega_c = 200$
DOF	2106	531	378	531

Fig. 15 compares the natural frequency vs. the corresponding vibration mode obtained from the eigenvalue analysis of the structure using the four cases of master degrees of freedom selection. For the lower vibration modes the four cases provide similar natural frequencies. In higher modes, however, the results from the Model-3, in which the cut-off frequency of 150 Hz is used to select the master degrees of

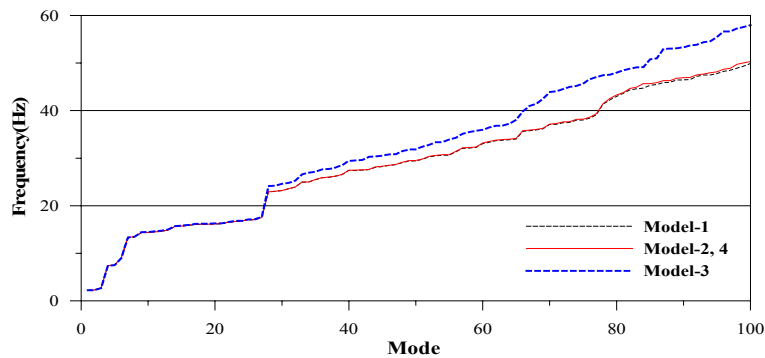
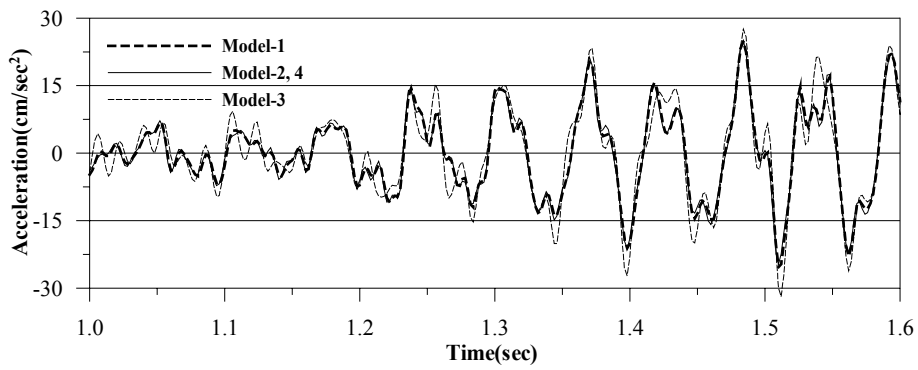

Fig. 15 Comparison of the natural frequency

freedom, deviate from the other values. The performance of the proposed method and the Shah and Raymund's method with the cut-off frequency of 200 Hz is quite satisfactory throughout the modes. But it should be noted that if the Shah and Raymund's method is to be followed, it would be necessary to find out the smallest cut-off frequency that satisfies the targeted accuracy. This will require an iterative procedure, which inevitably reduces the efficiency of the analysis. In contrast, the proposed method provides precise solution straightforwardly with incorporating less degrees of freedom.

The time histories of the acceleration obtained in the location A and B are plotted in Fig. 16 and Fig. 17. The difference can also be noticeable in the frequency contents of the response as shown in Fig. 17. The results computed from the proposed method turn out to be almost identical to those from the full model for the given loading type.



(a) Time history

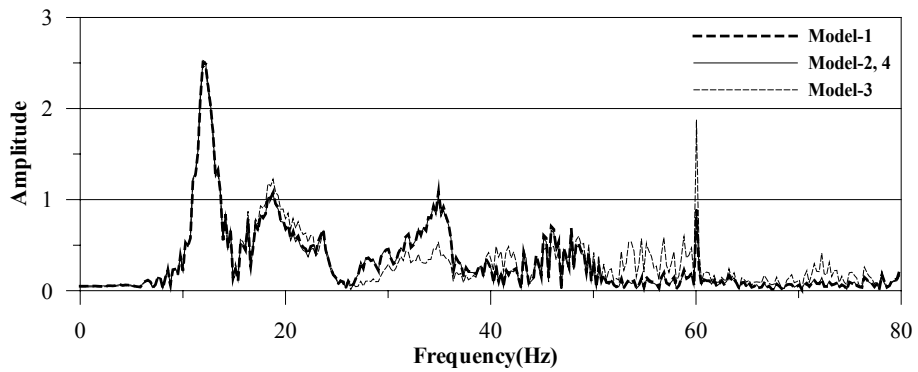

(b) Frequency contents

Fig. 16 Acceleration responses at node A

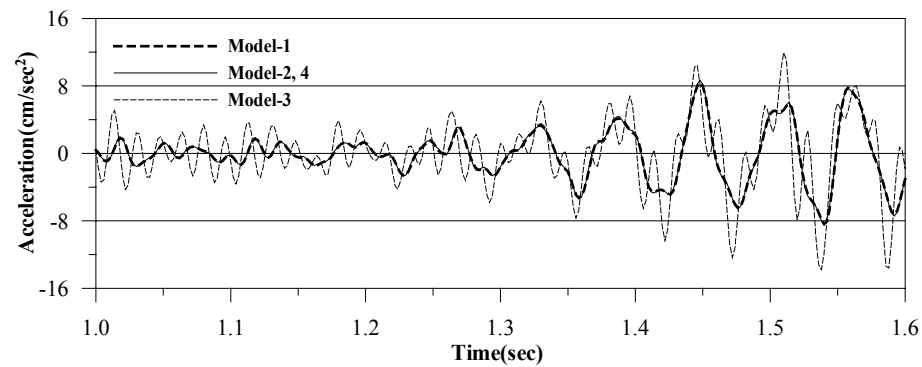

(a) Time history

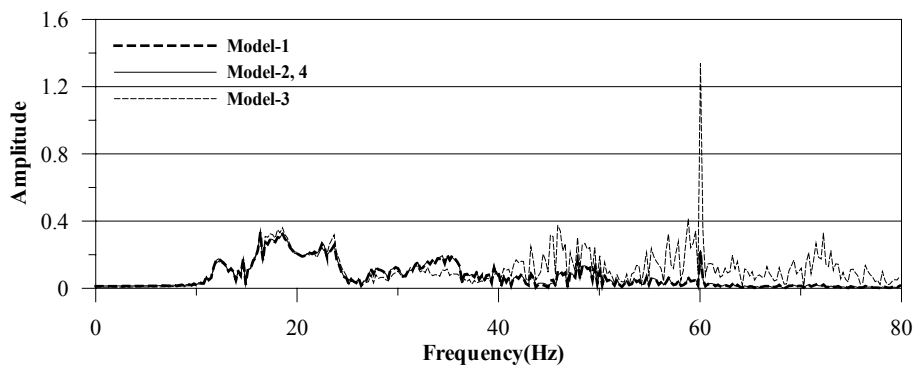

(b) Frequency contents

Fig. 17 Acceleration responses at node B

The efficiency of the proposed model can be verified by comparing the computation time. The time elapsed in each analytical step is listed in Table 5 for the four different modeling cases; full model with every degree of freedom considered, application of Guyan reduction to the full model, Guyan reduction with substructuring technique, and substructuring with super element. In the Guyan reduction process the proposed criterion is applied for the selection of master degrees of freedom. The analysis is carried out in a personal computer with Pentium III 550 MHz CPU and 256MB Ram. According to the results, in the full model most of the computation time is spent in the phase of eigenvalue analysis. It can be found that significant reduction in computation time is achieved when the Guyan reduction with substructuring technique is applied. A minute enhancement in efficiency is achieved in the assembly of system matrices by using super elements. The efficiency of using super element is expected to increase as the number of degrees of freedom and the scale of the structure increase.

Table 5 Computation time in each analytical step for the structure with slabs (sec)

Model \ Procedure	Assembly of M & K	Eigenvalue Analysis	Time history analysis	Total
Full model	14.02	3118.83	361.29	3494.14
Guyan reduction only	222.55	491.81	73.15	787.51
Substructuring with super element	4.00	46.06	72.55	122.61

Next example is the analysis of the three story, unsymmetric framed structure shown in Fig. 18. The member properties are the same with the previous example, and the same dynamic load is applied at point A. In case A, full model with all the degree of freedom is used, whereas in case B and C the Guyan reduction and substructuring with super elements are used, respectively, with the proposed method for master degrees of freedom. Fig. 19 and 20 show the acceleration response at points A and B, respectively.

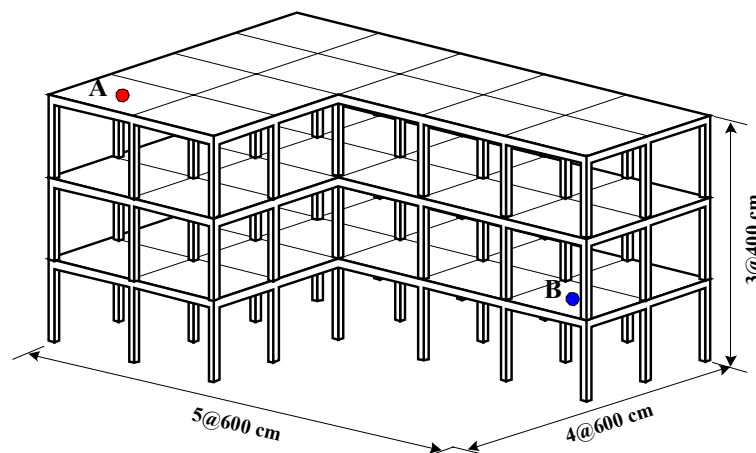

Fig. 18 Analytical model for unsymmetric building structure

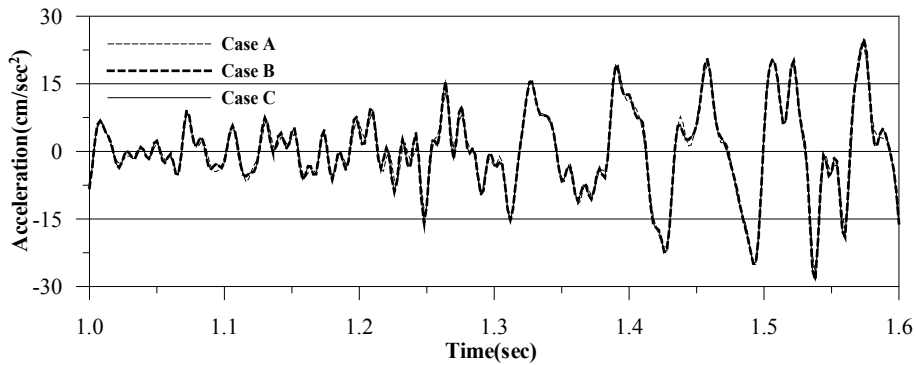

Fig. 19 Acceleration responses at node A

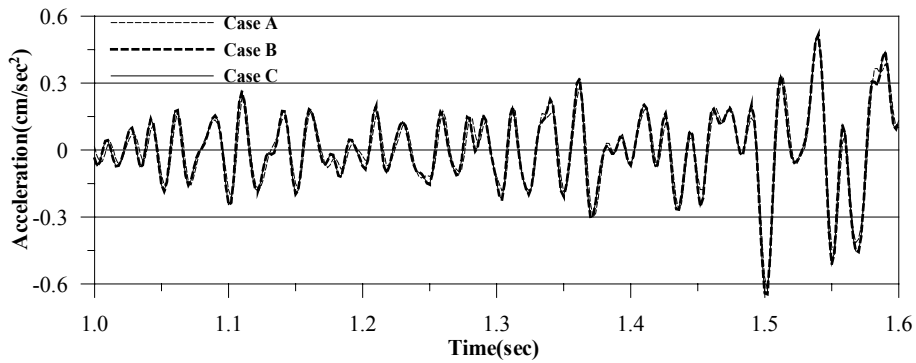

Fig. 20 Acceleration responses at node B

It can be seen in the figures that the responses at A obtained for three different cases are almost identical. At point B the results obtained for case B and C slightly deviate from those of case A; however the difference is practically negligible. Table 6 compares the computation time required for the analysis of the three cases. Compared with the previous example it can be noticed that the reduction in computation time for case C is quite outstanding, mainly because of the increase in the number of repeated parts (substructures).

Table 6 Computation time for the three cases of analytical modeling (min.)

Model	Case A (full model)	Case B (Guyan reduction)	Case C (substructure+super element)
Time	2753	54	9

In the final example the proposed method is applied to the 10 story framed RC structure subjected to vertical floor vibration at point *a* on the fifth floor as shown in Fig. 21. The member properties are listed in Table 7. In this example the dynamic load, which is described in Fig. 22, was obtained from acceleration records measured on the floor of a chemical plant vibrated by a rotating machine.

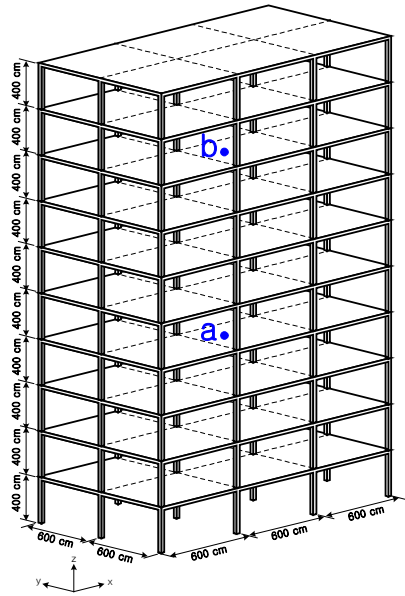

Fig. 21 Analytical model for large building structure 1

Table 7 Member size of the structure ( cm )

Story	Member		
	Column	Beam	Slab
1 ~ 3	75×75	60×40	18
4 ~ 6	60×60	60×40	18
7 ~ 10	45×45	60×40	18

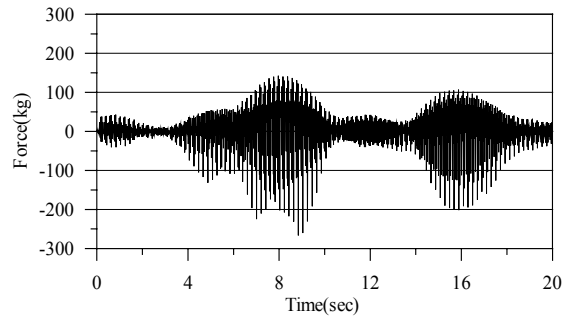
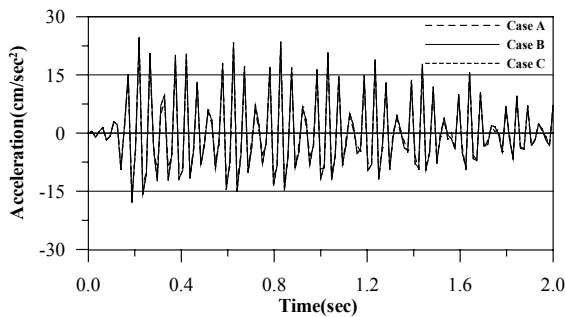

Fig. 22 Dynamic load Applied at point a

Table 8 shows that the Guyan reduction combined with the effective selection criterion of the master DOF greatly reduces the computation time. As expected the reduction effect is also significant in this larger model structure when the substructuring technique and the super elements are introduced. The acceleration responses plotted in Fig. 23 verify that the proposed method is very accurate as well as economical.

Table 8 Computation time for the three cases of analytical modeling (min.)

Model	Case A (full model)	Case B (Guyan reduction)	Case C (substructure+super element)
Time	3561	65	14



(a) Node a

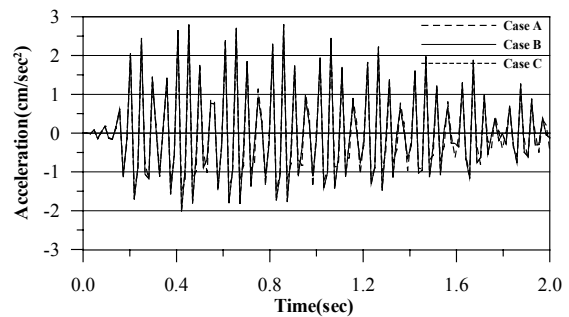

(b) Node b

Fig. 23 Acceleration responses for the large building structure

## 5. Conclusion

An efficient modeling technique for framed structure subjected to vertical dynamic excitation is presented. The proposed method utilizes the substructuring technique based on a rational and straightforward selection of master degrees of freedom. It is also shown that further enhancement of efficiency is possible by introducing the super elements when the number of degrees of freedom in a substructure becomes large. The findings of this study can be summarized as follows:

- The widely accepted criterion of selecting lower natural frequencies as master degrees of freedom for the Guyan reduction process may not be reliable for vertical vibration problems in framed structures, in which the natural frequencies of floor beams associated with the weak horizontal degrees of freedom occupy the low frequency range. Also the accuracy depends greatly on the way the cut-off frequency is chosen.
- The proposed selection technique that takes only vertical degrees of freedom inside of the floor and all 6 degrees of freedom in the interface is straightforward and robust regardless of the change in size of the structure and loading type.
- The use of substructuring technique combined with super elements can provide further efficiency in the process of modeling and analysis of a regular framed structure subjected to a vertical vibration.

## Acknowledgment

This work was supported (in part) by the Brain Korea 21 (BK21) of the Korean Ministry of Education. It can also supported by the Korea Science and Engineering Foundation (KOSEF) through the Korea Earthquake Engineering Research Center (KEERC) at the Seoul National University (SNU) under grant No. 97K3-1402-03-01-3. Their supports are greatly appreciated.

## Reference

- Guyan, R.J.(1965), "Reduction of stiffness and mass matrices", *Am.Inst. Aeronaut. Astronaut.*, 11(5), 380
- Levy, R. (1971), *Guyan reduction solutions recycled for improved accuracy*, NASTRAN User's Experiences, NASA, 201-220
- Ramsden, J.N. and Stocker, J.R. (1969), "Mass condensation a semi-automatic method for reducing the size of vibration problems", *Int. J. Numer. Meth. Engng.*, 1, 333-349
- Down, B. (1980), "Accurate reduction of stiffness and mass matrices for vibration analysis and a rationale for selecting master degrees of freedom", *J. Mech. Design*, ASME, 102
- Popplewell, N., Bertels, A.W.M. and Arya, B. (1973), "A critical appraisal of the eliminating technique", *J. Sound Vib.*, 32(2), 213-233
- Shah, V.N. and Raymund, M. (1982), "Analytical selection of masters for reduced eigenvalue problems", *Int. J. Mech. Engng.*, 18, 89-98
- Weaver, W.J. and Johnston, P.R. (1987), *Structural dynamics by Finite elements*, Rrentice-Hall